

9 M³ REOVEEMAHUTI

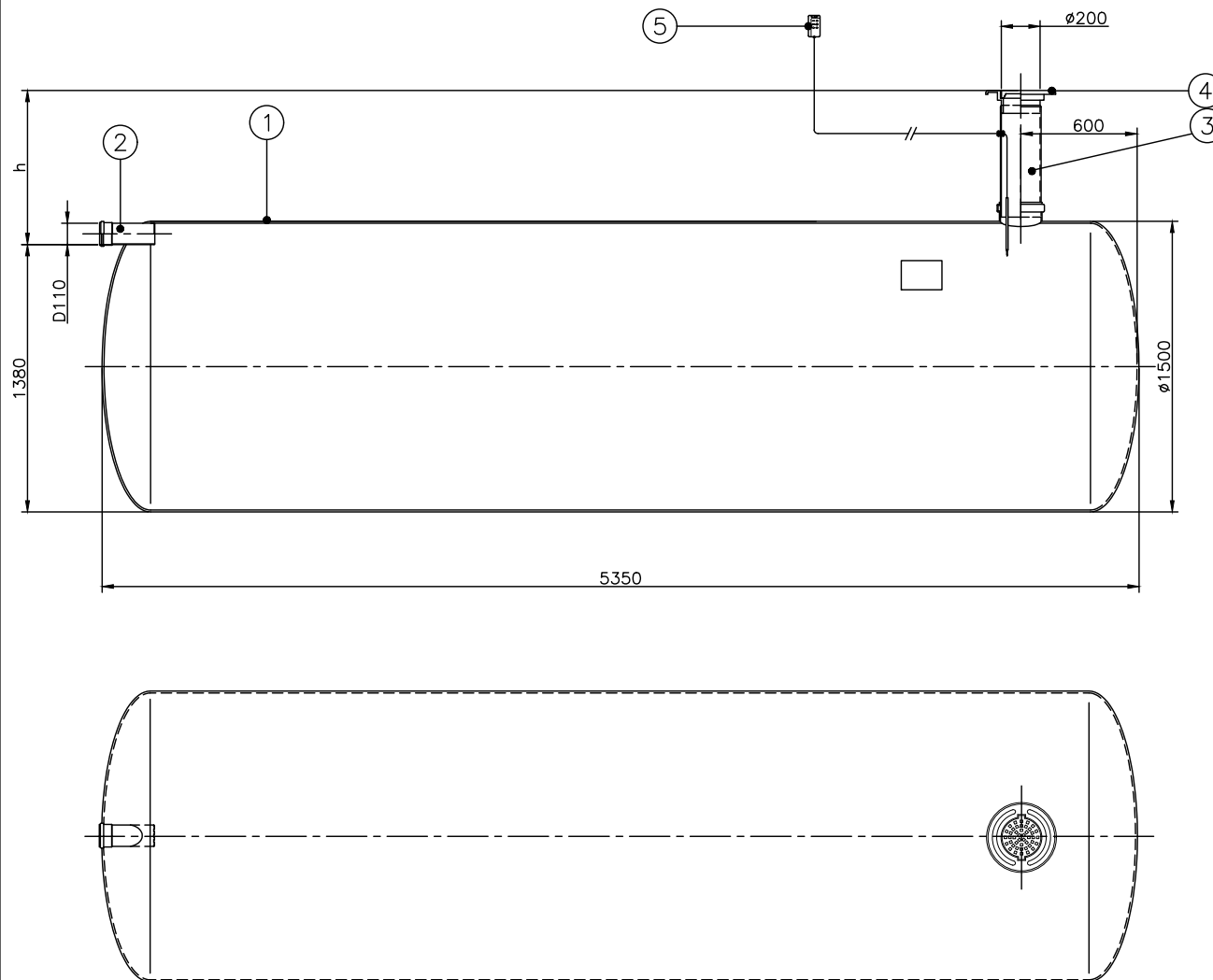

h = _____ mm (standardkõrgus 600 mm)

Nr	Nimetus	Materjal	Mõõdud	Tk
1	Mahuti korpus	klaasplast	Ø1500, L=5350	1
2	Sisendtoru	PVC	De110	1
3	Tühjendustoru	PVC	De200	1
4	Luuk	plast	Ø200, 0,1t	1
5	Avariinivoo alarm		juhtmega	

Joonis: Reoveemahuti 9m³